

ARTICLE

Field Measurement of NO₂ and RNO₂ by Two-channel Thermal Dissociation Cavity Ring down Spectrometer

Jian Chen^{a,b}, Hao Wu^a, An-wen Liu^a, Shui-ming Hu^{a*}, Jingsong Zhang^{a,b}*a. Hefei National Laboratory for Physical Sciences at the Microscale, University of Science and Technology of China, Hefei 230026, China**b. Department of Chemistry and Air Pollution Research Center, University of California, Riverside, California 92521, America*

(Dated: Received on May 2, 2017; Accepted on May 19, 2017)

A two-channel thermal dissociation cavity ring-down spectroscopy (CRDS) instrument has been built for *in situ*, real-time measurement of NO₂ and total RNO₂ (peroxy nitrates and alkyl nitrates) in ambient air, with a NO₂ detection limit of 0.10 ppbv at 1 s. A 6-day long measurement was conducted at urban site of Hefei by using the CRDS instrument with a time resolution of 3 s. A commercial molybdenum converted chemiluminescence (Mo-CL) instrument was also used for comparison. The average RNO₂ concentration in the 6 days was measured to be 1.94 ppbv. The Mo-CL instrument overestimated the NO₂ concentration by a bias of +1.69 ppbv in average, for the reason that it cannot distinguish RNO₂ from NO₂. The relative bias could be over 100% during the afternoon hours when NO₂ was low but RNO₂ was high.

Key words: Cavity ring-down spectroscopy, Molybdenum converted chemiluminescence, Thermal dissociation, Organic nitrates

I. INTRODUCTION

Nitrogen oxides (NO_x=NO+NO₂) play a vital role in atmospheric chemistry as formation and destruction of tropospheric ozone, acid deposition, and forming of nitrate radicals (NO₃) [1]. Most of the NO_x emission is in the form of NO from both natural (lightning, biomass burning, soil) and anthropogenic source (fossil combustion, motor vehicles) [2]. NO can rapidly be oxidized into NO₂ via various mechanisms (reactions with O₃, HO₂, and RO₂). O₃ can be formed from the photolysis of NO₂ under ultraviolet (UV) solar radiation ($\lambda < 420$ nm) [2–4] as follows:

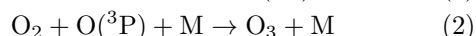
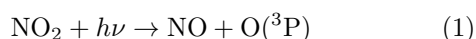

where M is a third body (usually N₂ or O₂). Reaction between OH radical and NO_x is an important loss process for OH radicals at urban sites.

NO₂ is designated as one of the six atmospheric pollutants declared by Chinese Ministry of Environmental Protection (MEP), namely sulfur dioxide (SO₂), nitrogen dioxide (NO₂), suspended particulates smaller than 10 μm (PM10) and those smaller than 2.5 μm (PM2.5) in aerodynamic diameter, carbon monoxide (CO), and

ozone (O₃), being measured at monitoring stations in each city [5]. Chemiluminescence (CL) technique is the most widely used technology recommended by US Environment Protection Agency (EPA) for NO₂ monitoring networks [6]. NO₂ is first converted to NO through reduction reaction by passing a heated (300–350 °C) metal-catalytic converter (usually molybdenum) following the detection of CL produced from the reaction of NO with O₃ to form electronically excited NO₂ [7, 8]. However, the reduction conversion is not specific for NO₂. Oxidized nitrogen compounds such as nitric acid (HNO₃), peroxy nitrates (PNs, RO₂NO₂), alkyl nitrates (ANs, RONO₂) may also be reduced to NO in a molybdenum converter at typical operating temperature under 400 °C [9, 10], which could lead to an overestimated NO₂ concentration at ambient conditions. PNs and ANs can yield NO₂ at a ratio of 1:1 when they are heated and undergo thermal decomposition. The reported temperatures for complete dissociation (>99%) are 200 °C for PNs, 400 °C for ANs, and 650 °C for HNO₃, respectively [11–14]. These extra NO₂ can bring in a bias of NO₂ detection when CL instruments are equipped with molybdenum converter (Mo-CL).

More specific techniques for NO₂ detection have been developed, including CL instrument equipped with a photolytic converter (P-CL) [15, 16], laser induced fluorescence (LIF) [11, 17–20], differential optical absorption spectroscopy (DOAS) [18, 21–23], tunable infrared laser differential absorption spectroscopy (TILDAS) [22, 24], cavity ring down spectroscopy (CRDS) [25–28],

* Author to whom correspondence should be addressed. E-mail: smhu@ustc.edu.cn

cavity attenuated phase shift (CAPS) spectroscopy [29–32], and Faraday rotation spectroscopy (FRS) [33, 34]. Steinbacher *et al.* [15] measured NO₂ concentration with both P-CL and Mo-CL instruments in rural Switzerland with up to 30% bias on a monthly basis. Dunlea *et al.* [22] found averaged 22% overestimated NO₂ levels by Mo-CL compared with DOAS and TILDAS technique in Mexico city, and the bias could be up to 50% during afternoon hours. Ge *et al.* [31, 32] reported an overestimated NO₂ level by Mo-CL up to 20% compared with CAPS in the afternoon hours in Beijing. Besides, Cao *et al.* [16] gave an averaged bias of +3.72 ppbv by NO-CL comparing with P-CL during a 30-day long ambient measurement in Beijing.

As a technique for detecting optical absorption of molecules, CRDS enhances the absorption path length as the light travels many times in the resonance cavity resulting in a superior sensitivity in detecting molecules at ultra-low concentrations. CRDS has been used as a powerful tool for trace gas detection since it was first developed by O’Keefe and Deacon [35]. Brown *et al.* used CRDS for ambient pollutants detection as NO₂, O₃, NO₃, and N₂O₅ [25, 36–39]. Taking advantage of the thermal instability of ANs and PNs, Osthoff *et al.* conducted a thermal dissociation cavity ring down spectroscopy (TD-CRDS) instrument to detect ANs and PNs in laboratory [40, 41]. Very recently, a five-channel cavity ring-down spectrometer with thermal dissociation region has been built for the field detection of NO₂, NO₃, N₂O₅, PNs and ANs [42], and a two-channel thermal dissociation cavity ring-down spectrometer was implemented to detect ambient NO₂, RO₂NO₂, and RONO₂ [43].

In this study, we present a two-channel TD-CRDS for measurements of NO₂ and RNO₂ (PNs+ANs). We conducted a 6-day long measurement of NO₂ by two-channel TD-CRDS and a commercial Mo-CL instrument. By comparing the results from Mo-CL and CRDS, we evaluated the accuracy of the CRDS instrument and investigated the reasons causing deviations in the Mo-CL instrument. We demonstrated that the high sensitivity (0.1 ppbv@1 s) and fast response of the CRDS instrument are very useful for real-time measurement in field studies.

II. EXPERIMENTS

The configuration of two-channel CRDS setup is shown in FIG. 1. A 405 nm diode laser (PTI, IQ μ 2A) with an output power of about 100 mW was used as the light source. The laser is centered at 405.46 nm with a line width of about 0.5 nm which was measured by a grating spectrometer (Shamrock750). The laser was switched on and off with rising time of about 10 ns by a 1 kHz TTL signal. After passing through an optical isolator, the light was split (50/50) and coupled into two ring-down cavities each consisted of two high

reflective (HR) mirrors (ATFilms, $R \approx 99.995\%$). Each cavity was about 87 cm long and made of PFA (Perfluoroalkoxy alkanes) tube, with an outer diameter of 3/4 inch. The HR mirrors were protected by purging in dry nitrogen. All the gas flow was controlled by mass flow controllers (Omega) leading to a stable pressure in the cavity. The purge gas of nitrogen is 150 mL/min, and the flow rate of ambient gas is 1 L/min. PTFE (polytetrafluoroethylene) membrane filters (whatman, pore size 0.2 μ m) were used to remove particles when sampling ambient air. The light emitting from the cavity was detected by a photomultiplier tube (PMT) and recoded by a digitizer (ADlink).

The molecule concentration N (molecule/cm³) in the RD cavity can be derived from the equation below:

$$N\sigma = \frac{R_L}{c} \left(\frac{1}{\tau} - \frac{1}{\tau_0} \right) \quad (3)$$

where c is the speed of light, σ is the effective absorption cross section of NO₂ at 405 nm, which is 6.45×10^{-19} cm²/molecule at room temperature (294 K) [44]. τ and τ_0 are the decay time with and without sample, respectively. R_L is the ratio of optical length between two HR mirrors and sample length. Light with wavelength smaller than 420 nm could lead to photolysis of NO₂ [4]. The photolysis rate coefficient of NO₂ at half sun is about 5×10^{-3} or 0.01 s⁻¹ with sunlight density of 1000 W/m² [45, 46], and it is linear to the light intensity [46]. The photolysis ratio of NO₂ is about 0.1% under our experiment conditions.

The reference CRDS channel (FIG. 1, labeled as Chan.2) was used to detect the absorption of NO₂ molecules in the sample gas. Another channel (FIG. 1, labeled as Chan.1) was used in parallel to detect additional NO₂ dissociated by RNO₂ (peroxy nitrates and alkyl nitrates). Before ambient air flew into the cavity, it passed through a 25-cm-long quartz tube (4 mm inner diameter, 6 mm outer diameter) heated to 440 °C with temperature fluctuation within 1 °C. The heating zone is similar to the design in Ref.[11] to ensure that over 99% of RNO₂ will dissociate to produce NO₂ at a ratio of 1:1.

A commercial Mo-CL NO_x analyzer based on CL measurement of NO (Thermo Fisher Scientific, 42i-TL) was used to calibrate the CRDS instrument. The Model 42i-TL instrument operates on the principle that nitric oxide (NO) and ozone (O₃) react to produce a characteristic luminescence with intensity linearly proportional to the NO concentration. NO₂ can also be detected by the instrument, after being converted to NO by a molybdenum converter heated to about 325 °C. A mode solenoid valve is used to switch between two modes: with sample flowing through the molybdenum converter (NO_x mode) or bypassing the molybdenum converter (NO mode). The difference between the NO concentrations detected in these two modes is used to derive the NO₂ concentration. The NO₂ detection limit of 42i-TL is 50 pptv at an averaging time of 120 s.

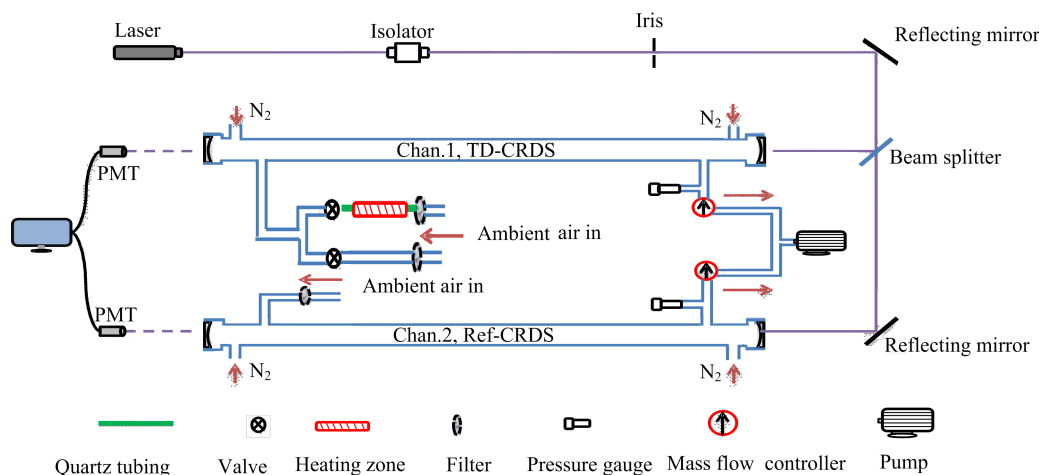

FIG. 1 Configuration of two-channel CRDS setup.

Diluted NO_2 gas samples were measured by both CRDS (two channels, without thermal dissociation) and Mo-CL analyzer (42i-TL analyzer). During the process of about 5 h, an NO_2 sample was diluted by dry pure nitrogen and the NO_2 concentration was determined by the Mo-CL analyzer. The results are used to determine the factor R_L of the CRDS instrument. When a RL factor of 1.75 was applied, the CRDS results agree perfectly with the CL analyzer, which is illustrated in FIG. 2. The residual discrepancy is below 0.2 ppbv, being consistent with the uncertainty of the CL analyzer and the fluctuations of diluted NO_2 gas.

RNO_2 channel (labeled as Chan.1 in Fig.1) could detect extra NO_2 produced by the dissociation of RNO_2 when the sample gas passed through the heating zone. When the TD tube was bypassed, the NO_2 detected by two channels agreed well with each other with a discrepancy below 0.2 ppbv. Meanwhile, the extra NO_2 concentration (1:1 to RNO_2) was about 2 ppbv when the ambient air was measured, confirming that the difference was due to RNO_2 .

III. RESULTS AND DISCUSSION

In order to test the performance of the instrument, we took a 6-day continuous measurement of ambient NO_2 and RNO_2 in Hefei, China. The monitoring location was in the west campus of USTC, with a height of about 12 m, and about 30 m from a main street. The air sample flowed directly into the reference CRDS channel and the Mo-CL analyzer, and passed through the heating region at the TD channel. The experiment lasted for about 7 days from January 11 to January 17, 2017. During the experiment, every 11–12 h the TD tube was bypassed to verify the agreement between the NO_2 concentrations detected by the two CRDS channels. During the whole experiment, the discrepancy was below 0.2 ppbv.

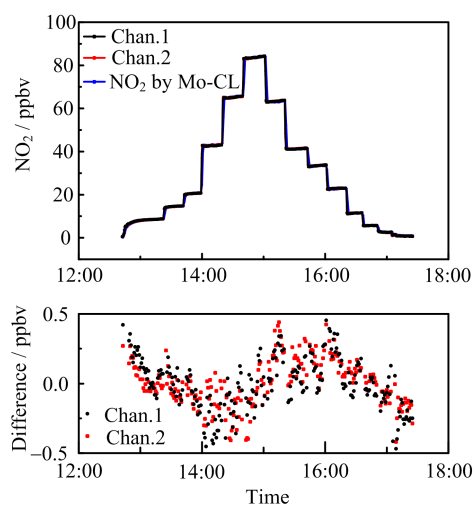

FIG. 2 Measurements of diluted NO_2 gas sample by the Mo-CL analyzer (42i-TL) and two-channel CRDS setup. Upper panel: NO_2 concentrations during dilution process. Lower panel: deviations between the NO_2 concentrations obtained from each CRDS channel and the Mo-CL analyzer.

The NO_2 data by Mo-CL had a time resolution of 1 min with 1 min averaging time. While the NO_2 data by CRDS had a time resolution of about 3 s. For comparison, the NO_2 and $\text{RNO}_2 + \text{NO}_2$ data by CRDS have been averaged to 1 min resolution. As shown in FIG. 3, the NO_2 concentration detected by Mo-CL analyzer actually agreed better with the TD channel (Chan.1, $\text{RNO}_2 + \text{NO}_2$), being significantly higher than the reference channel (Chan.2, NO_2).

It turned out that NO_2 rose from 8:00 in the morning, and reached its maxima till 10:00. Another rising process began at about 16:00 in the afternoon. The rising of NO_2 could be attributed to the NO_x emission from motor vehicles during the traffic jam hours in the morning. As the growth of solar radiation, the photolysis of

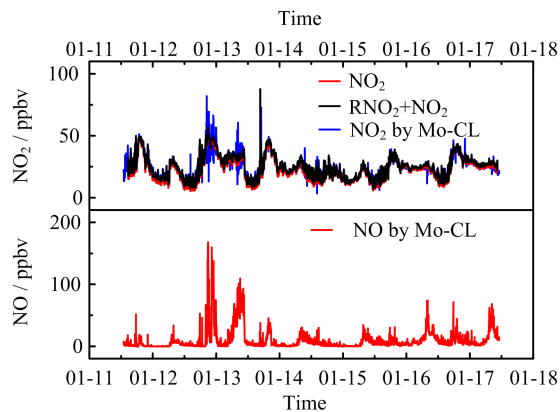

FIG. 3 Ambient concentration of NO_2 (upper panel) by CRDS and by the Mo-CL analyzer (42i-TL), NO (lower panel) by the Mo-CL analyzer.

NO_2 resulted in the decrease of NO_2 . The emission of NO_x from the traffic jam occurred at about 16:00 and led to the accumulation of NO_2 until the evening. The increase of NO_2 was always accompanied by a simultaneous increase of NO more or less. Note that around 16:30 January 13, there was a sharp peak of NO_2 with concentration of about 90 ppbv.

During two periods, from 18:00 of January 12 till early morning of January 13, and from about 8:00 till noon of January 13, NO_2 detected by Mo-CL analyzer significantly deviated from the CRDS results. The rapid fluctuation of NO could be attributed to local emission. The sample site is close to a main street with lots of heavy vehicles running in the night time. This was possibly the reason of sharp NO signals. As better illustrated in FIG. 4, the discrepancy could reach as high as 40 ppbv, or relatively about 100%. At the same time, we observed rapid change of NO. Since the Mo-CL analyzer measures NO_2 by converting it to NO, the readout can be distorted when the NO concentration is changing. A mode solenoid valve inside the Mo-CL analyzer determines whether the sample flows through the molybdenum converter (NO_x mode) or bypasses the molybdenum converter (NO mode). The difference between the two modes is used to derive the NO_2 concentration. The method is only valid assuming that the NO concentration changes slowly. However, the NO concentration can change a lot when switching between the NO_x mode and the NO mode.

Moreover, the molybdenum convertor was not specific for NO_2 , some other species reactive nitrogen as HONO, HNO_3 , and RNO_2 could also be converted to NO [9, 10]. Besides, RNO_2 could produce extra NO_2 in the molybdenum converter heated to 325 °C. These effects lead to a bias in NO_2 measurements using a Mo-CL analyzer.

A result of such effect is shown in FIG. 5. With a time resolution of 3 s, we can clearly identify the change of NO_2 and RNO_2 within the an-hour period. NO_2 de-

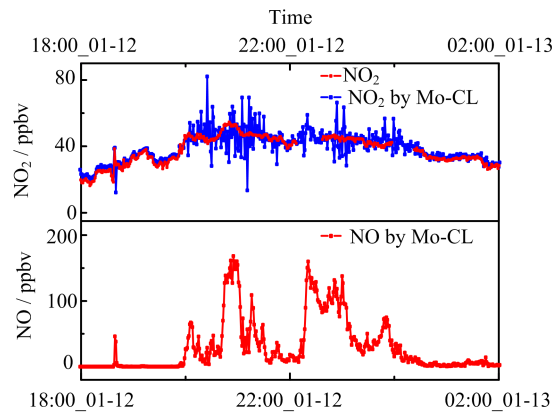

FIG. 4 Interference of the NO_2 concentration measured by Mo-CL (1 min resolution) analyzer due to rapid change of NO concentration. The discrepancy of NO_2 concentration could be over 40 ppbv when compared with the NO_2 concentration measured by CRDS (1 min resolution). NO concentration shown in the lower panel.

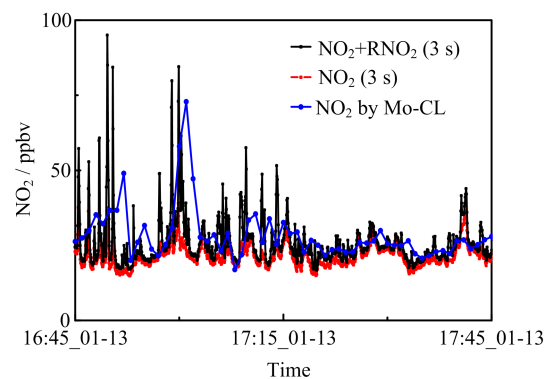

FIG. 5 NO_2 concentration around 17:00, January 13: NO_2 by TD-channel (black points) and reference channel (red points) were of 3 s time resolution; NO_2 by Mo-CL analyzer were of 1 min time resolution.

tected by reference channel ranged from 20 ppbv to 30 ppbv during the period. The difference between TD channel and reference channel represented the concentration of RNO_2 . There were several sharp peaks of RNO_2 as large as 55 ppbv in the first several minutes in FIG. 5. However, the NO_2 concentration given by Mo-CL analyzer was apparently larger than the result from the CRDS reference channel. The reason was that the RNO_2 concentration had been wrongly included. The bias between Mo-CL analyzer and the CRDS reference channel was 45.3 ppbv (relatively 165%). The bias could be attributed to the reduction of other oxidized nitrogen compounds including RNO_2 .

The Mo-CL analyzer tends to overestimate the NO_2 concentration. The effect during the 6-day-measurement is illustrated in FIG. 6, by the ratio of the NO_2 concentration given by Mo-CL analyzer to that by CRDS. The ratio was higher than 1 at most of the time, and sometimes even reached 2. Notice that the

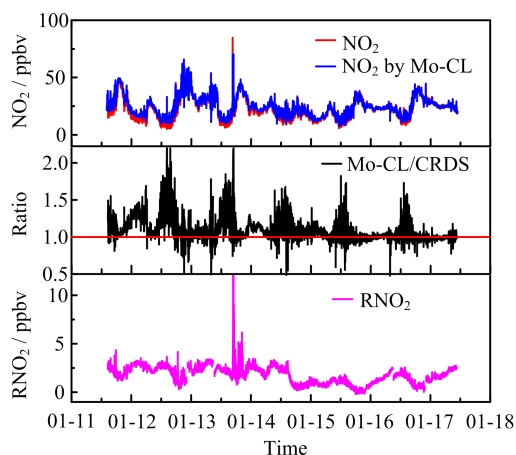

FIG. 6 NO_2 concentration detected by Mo-CL analyzer and CRDS. Upper panel: NO_2 concentration by Mo-CL analyzer (1 min resolution) and reference channel (1 min resolution); middle panel: ratio of Mo-CL analyzer and reference channel; bottom panel: RNO_2 concentration determined from two-channel CRDS.

ratio started to increase before the noon and peaks appeared in the afternoon when the concentration of NO_2 decreased to the bottom level. The trend was consistent with the results of contrast experiment with Mo-CL instruments [15, 16, 22, 31, 32]. As a result of the photolysis of NO_2 , the appearance of bottom concentration of NO_2 in the afternoon indicated sufficient solar radiation of that day which led to abundant oxidants as O_3 and OH (mostly from photolysis of HONO) [3]. RO_2 radical was formed during the oxidation process of volatile organic compounds (VOC) by O_3 and OH , and it then reacted with NO_x to form RNO_2 . Similar diurnal variation of RNO_2 could be seen in FIG. 6, with peaks occurring in the afternoon. Relatively high level of RNO_2 and other oxidized nitrogen compounds but low level of NO_2 were the reason that the Mo-CL instrument gave considerably larger deviation in the detected concentration of NO_2 .

IV. CONCLUSION

A two-channel cavity ring-down spectroscopy (CRDS) instrument was built for real-time measurement of NO_2 and RNO_2 (peroxy nitrates and alkyl nitrates) in ambient air. We realized a detection limit of NO_2 and RNO_2 of 0.1 ppbv at one second. A 6-day-long field study has been carried out by using the CRDS instrument with a time resolution of 3 s. A commercial chemiluminescence instruments equipped with molybdenum converter (Mo-CL) NO_x analyzer was also used for a comparison. We evidenced that the Mo-CL NO_x analyzer could be interfaced by NO rapid fluctuation in ambient air, reduction of oxidized nitrogen species and thermal dissociation of RNO_2 in

the molybdenum converter. The average NO_2 given by the Mo-CL analyzer during the 6-day experiment was 24.62 ppbv, with 1.69 ppbv higher than that given by the CRDS instrument, coinciding with the averaged RNO_2 concentration of 1.94 ppbv. We also observed that the Mo-CL analyzer could overestimate the NO_2 concentration by 100%, when the NO_2 concentration was low but RNO_2 was relatively high in the afternoon.

As the growing of demand for accurate and rapid detection of pollutants in ambient air, CRDS could be used to detect NO , NO_2 at the same time with equivalent detection limit compared to Mo-CL NO_x analyzer [38], but with much higher time resolution, which can be used to monitor the sudden emissions at local sites. Compared with the widely applied Mo-CL NO_x analyzer, CRDS setup could be a better choice to measure NO_2 in the ambient air since it directly detect the absorption of NO_2 . CRDS combined with thermal dissociation of RNO_2 to NO_2 , TD-CRDS, could be used to evaluate the concentration of RNO_2 in ambient air.

V. ACKNOWLEDGEMENTS

This work was supported from the Ministry of Science and Technology of China (No.2013CB834602 and 2013BAK12B00), the National Natural Science Foundation of China (No.21427804 and No.21225314).

- [1] P. J. Crutzen, *Annu. Rev. Earth Planet. Sci.* **7**, 443 (1979).
- [2] B. J. Finlayson-Pitts and J. N. Pitts Jr., *Chemistry of the Upper and Lower Atmosphere*, San Diego: Academic Press, (2000).
- [3] R. Atkinson, *Atmos. Environ.* **34**, 2063 (2000).
- [4] J. H. Seinfeld and S. N. Pandis, *Atmospheric Chemistry and Physics: From Air Pollution to Climate Change*, 2nd Ed., New York: John Wiley & Sons, Inc., (2012).
- [5] People's Republic of China Ministry of Environmental Protection Standard, *Technical Regulation on Ambient Air*, Beijing: People's Republic of China Ministry of Environmental Protection, (2012).
- [6] K. L. Demerjian, *Atmos. Environ.* **34**, 1861 (2000).
- [7] A. Fontijn, A. J. Sabadell, and R. J. Ronco, *Anal. Chem.* **42**, 575 (1970).
- [8] B. A. Ridley and L. C. Howlett, *Rev. Sci. Instrum.* **45**, 742 (1974).
- [9] F. C. Fehsenfeld, R. R. Dickerson, G. Hbler, W. T. Luke, L. J. Nunnermacker, E. J. Williams, J. M. Roberts, J. G. Calvert, C. M. Curran, A. C. Delany, C. S. Eubank, D. W. Fahey, A. Fried, B. W. Gandrud, A. O. Langford, P. C. Murphy, R. B. Norton, K. E. Pickering, and B. A. Ridley, *J. Geophys. Res. Atmos.* **92**, 14710 (1987).
- [10] E. J. Williams, K. Baumann, J. M. Roberts, S. B. Bertman, R. B. Norton, F. C. Fehsenfeld, S. R. Springston, L. J. Nunnermacker, L. Newman, K. Olszyna, J. Meagher, B. Hartsell, E. Edgerton, J. R. Pearson, and

- M. O. Rodgers, *J. Geophys. Res. Atmos.* **103**, 22261 (1998).
- [11] D. A. Day, P. J. Wooldridge, M. B. Dillon, J. A. Thornton, and R. C. Cohen, *J. Geophys. Res. Atmos.* **107**, ACH 4-1 (2002).
- [12] I. M. Pérez, P. J. Wooldridge, and R. C. Cohen, *Atmos. Environ.* **41**, 3993 (2007).
- [13] P. J. Wooldridge, A. E. Perring, T. H. Bertram, F. M. Flocke, J. M. Roberts, H. B. Singh, L. G. Huey, J. A. Thornton, G. M. Wolfe, J. G. Murphy, J. L. Fry, A. W. Rollins, B. W. LaFranchi, and R. C. Cohen, *Atmos. Meas. Tech.* **3**, 593 (2010).
- [14] R. J. Wild, P. M. Edwards, W. P. Dub, K. Baumann, E. S. Edgerton, P. K. Quinn, J. M. Roberts, A. W. Rollins, P. R. Veres, C. Warneke, E. J. Williams, B. Yuan, S. S. Brown, *Environ. Sci. Technol.* **48**, 9609 (2014).
- [15] M. Steinbacher, C. Zellweger, B. Schwarzenbach, S. Bugmann, B. Buchmann, C. Ordóñez, A. S. H. Prevot, and C. Hueglin, *J. Geophys. Res. Atmos.* **112**, D11307 (2007).
- [16] W. Cao, L. M. Zeng, Y. S. Wu, and X. N. Yu, *Acta Sci. Circumst.* **35**, 670 (2015).
- [17] J. A. Thornton, P. J. Wooldridge, and R. C. Cohen, *Anal. Chem.* **72**, 528 (2000).
- [18] J. A. Thornton, P. J. Wooldridge, R. C. Cohen, E. J. Williams, D. Hereid, F. C. Fehsenfeld, J. Stutz, and B. Alicke, *J. Geophys. Res. Atmos.* **108**, 4496 (2003).
- [19] P. A. Cleary, P. J. Wooldridge, and R. C. Cohen, *Appl. Opt.* **41**, 6950 (2002).
- [20] H. Suzuki, Y. Miyao, T. Nakayama, J. K. Pearce, Y. Matsumi, K. Takahashi, K. Kita, and K. Tonokura, *Atmos. Environ.* **45**, 6233 (2011).
- [21] U. Platt, D. Perner, and H. W. Patz, *J. Geophys. Res. Oceans* **84**, 6329 (1979).
- [22] E. J. Dunlea, S. C. Herndon, D. D. Nelson, R. M. Volkamer, F. San Martini, P. M. Sheehy, M. S. Zahniser, J. H. Shorter, J. C. Wormhoudt, B. K. Lamb, E. J. Allwine, J. S. Gaffney, N. A. Marley, M. Grutter, C. Marquez, S. Blanco, B. Cardenas, A. Retama, C. R. RamosVillegas, C. E. Kolb, L. T. Molina, and M. J. Molina, *Atmos. Chem. Phys.* **7**, 2691 (2007).
- [23] G. Villena, I. Bejan, R. Kurtenbach, P. Wiesen, and J. Kleffmann, *Atmos. Meas. Tech.* **5**, 149 (2012).
- [24] Y. Q. Li, K. L. Demerjian, M. S. Zahniser, D. D. Nelson, J. B. McManus, and S. C. Herndon, *J. Geophys. Res. Atmos.* **109**, D16S08 (2004).
- [25] H. D. Osthoff, S. S. Brown, T. B. Ryerson, T. J. Fortin, B. M. Lerner, E. J. Williams, A. Pettersson, T. Baynard, W. P. Dubé, S. J. Ciciora, and A. R. Ravishankara, *J. Geophys. Res. Atmos.* **111**, D12305 (2006).
- [26] P. Castellanos, W. T. Luke, P. Kelley, J. W. Stehr, S. H. Ehrman, and R. R. Dickerson, *Rev. Sci. Instrum.* **80**, 113107 (2009).
- [27] R. Wada and A. J. Orr-Ewing, *Analyst* **130**, 1595 (2005).
- [28] H. Fuchs, W. P. Dube, B. M. Lerner, N. L. Wagner, E. J. Williams, and S. S. Brown, *Environ. Sci. Technol.* **43**, 7831 (2009).
- [29] P. L. Keabian, S. C. Herndon, and A. Freedman, *Anal. Chem.* **77**, 724 (2005).
- [30] P. L. Keabian, E. C. Wood, S. C. Herndon, and A. Freedman, *Environ. Sci. Technol.* **42**, 6040 (2008).
- [31] B. Z. Ge, Y. L. Sun, Y. Liu, H. B. Dong, D. S. Ji, Q. Jiang, J. Li, and Z. F. Wang, *J. Geophys. Res. Atmos.* **118**, 9499 (2013).
- [32] B. Z. Ge, Z. F. Wang, Y. L. Sun, H. B. Dong, D. S. Ji, Y. Liu, and Q. Jiang, *Environ. Chem.* **33**, 1558 (2014).
- [33] K. Liu, R. Lewicki, and F. K. Tittel, *Sensors Actuat. B* **237**, 887 (2016).
- [34] R. Lewicki, K. Liu, T. Day, and F. K. Tittel, *Sub-ppb detection of Nitrogen Dioxide with an External Cavity Quantum Cascade Laser, Proceedings of SPIE 8268, Quantum Sensing and Nanophotonic Devices IX, 82682H*, San Francisco, California, USA: SPIE (2012).
- [35] A. O'Keefe and D. A. G. Deacon, *Rev. Sci. Instrum.* **59**, 2544 (1988).
- [36] S. S. Brown, H. Stark, S. J. Ciciora, and A. R. Ravishankara, *Geophys. Res. Lett.* **28**, 3227 (2001).
- [37] S. S. Brown, H. Stark, S. J. Ciciora, R. J. McLaughlin, and A. R. Ravishankara, *Rev. Sci. Instrum.* **73**, 3291 (2002).
- [38] S. S. Brown, H. Stark, T. B. Ryerson, E. J. Williams, D. K. Nicks Jr, M. Trainer, F. C. Fehsenfeld, and A. R. Ravishankara, *J. Geophys. Res. Atmos.* **108**, 4299 (2003).
- [39] R. A. Washenfelder, N. L. Wagner, W. P. Dube, and S. S. Brown, *Environ. Sci. Technol.* **45**, 2938 (2011).
- [40] D. Paul and H. D. Osthoff, *Anal. Chem.* **82**, 6695 (2010).
- [41] D. Paul, A. Furgeson, and H. D. Osthoff, *Rev. Sci. Instrum.* **80**, 114101 (2009).
- [42] N. Sobanski, J. Schuladen, G. Schuster, J. Lelieveld, and J. N. Crowley, *Atmos. Meas. Tech.* **9**, 5103 (2016).
- [43] J. Thieser, G. Schuster, J. Schuladen, G. J. Phillips, A. Reiffs, U. Parchatka, D. Pöhler, J. Lelieveld, and J. N. Crowley, *Atmos. Meas. Tech.* **9**, 553 (2016).
- [44] L. S. Rothman, I. E. Gordon, Y. Babikov, A. Barbe, D. Chris Benner, P. F. Bernath, M. Birk, L. Bizzocchi, V. Boudon, L. R. Brown, A. Campargue, K. Chance, E. A. Cohen, L. H. Coudert, V. M. Devi, B. J. Drouin, A. Fayt, J. M. Flaud, R. R. Gamache, J. J. Harrison, J. M. Hartmann, C. Hill, J. T. Hodges, D. Jacquemart, A. Jolly, J. Lamouroux, R. J. Le Roy, G. Li, D. A. Long, O. M. Lyulin, C. J. Mackie, S. T. Massie, S. Mikhailenko, H. S. P. Mller, O. V. Naumenko, A. V. Nikitin, J. Orphal, V. Perevalov, A. Perrin, E. R. Polovtseva, C. Richard, M. A. H. Smith, E. Starikova, K. Sung, S. Tashkun, J. Tennyson, G. C. Toon, V. G. Tyuterev, and G. Wagner, *J. Quantit. Spectrosc. Radiat. Transfer* **130**, 4 (2013).
- [45] R. R. Dickerson and D. H. Stedman, *Environ. Sci. Technol.* **14**, 1261 (1980).
- [46] I. Trebs, B. Bohn, C. Ammann, U. Rummel, M. Blumthaler, R. K?nigstedt, F. X. Meixner, S. Fan, and M. O. Andreae, *Atmos. Meas. Tech.* **2**, 725 (2009).